

**MQ15-X-Power male 0° shielded with cable**

PUR 4x2,5+2x1,5 or UL/CSA + draig chain 3m

Male straight

MQ15, 6-pole

shielded

without cable sleeves

Plastic housings with good resistance against chemicals and oils.

The resistance to aggressive media should be individually tested for your application. Further details on request.

Further cable lengths on request.

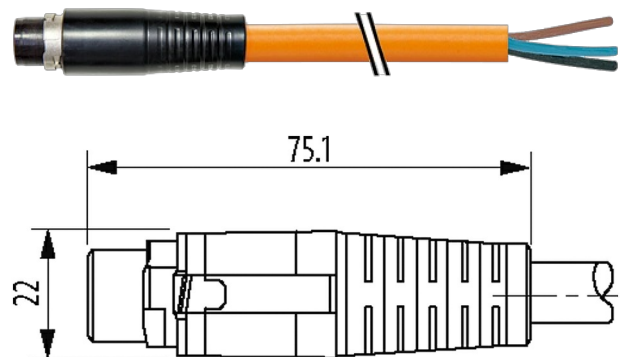
**[Link to Product](#)****Illustration**

Product may differ from Image

**Form**

Form P8301

**General data**

Mounting method	inserted, tightened
Material (contact carrier)	PA
Material (contact)	Copper alloy
Material (contact surface)	Ag
Stripping length (jacket)	30 mm
Pollution Degree	3
Temperature range	-25...+80 °C, depending on cable quality

**Cables**

No./diameter of wires	4 × 2.5 + 2 × 1.5 mm <sup>2</sup>
Wire isolation	TPM (bk num, gnye)
C-track properties	5 Mio.
Jacket Color	orange
Material (jacket)	PUR (UL)
Outer Ø	12.8 mm ±5%
Bend radius (moving)	10 × outer Ø
Temperature range (fixed)	-25...+80 °C
Temperature range (mobile)	-20...+80 °C
Cable identification	P11
Material (wire)	Cu wire, bare
Resistor (core)	max. 14 Ω/km (1.5 mm <sup>2</sup> ), max. 8.5 Ω/km (2.5 mm <sup>2</sup> ); (20 °C)

Construction (core)	multi-strand wire class 5 (EN 60228)
Diameter (core)	4 × 2.5 + 2 × 1.5 mm <sup>2</sup>
Material (wire isolation)	TPM
Color/numbering of wires	bk numbered, gnye longitudinally striped
Shield	yes
Material (jacket)	PUR
Outer-Ø (jacket)	12.8 mm ±5%
Color (jacket)	orange
thermal resistance	flame retardant
Nominal voltage	1000 V AC
Test voltage	4000 V
Temperature range (fixed)	-40...+80 °C
Temperature range (mobile)	-20...+80 °C
Bend radius (fixed)	5 × outer Ø
Bend radius (moving)	10 × outer Ø
Traversing distance (C-track)	max. 5 m (horizontal)
Travel speed (C-track)	max. 3 m/s
Acceleration (C-track)	max. 5 m/s <sup>2</sup>
Torsion stress	±15 °/m

#### Technical Data

Operating voltage	max. 600 V AC (Power); max. 63 V AC/DC (Signal)
Rated surge voltage	4.0 kV
Operating current per contact	max. 16 A (Power); max. 10 A (Signal)
No. of poles	6
LED display	no
Locking of ports	Quick connection, 1/4 turn
Protection	IP67 inserted and tightened (EN 60529)
Material	Flame retardant plastic acc. to (UL 94)
Mating cycles	≥ 500
Configuration	fully used
Material group	IEC 60664-1, category I

#### Commercial data

country of origin	DE
customs tariff number	85444290
EAN	4048879701464
eClass	27279221
Packaging unit	1

#### Sketch

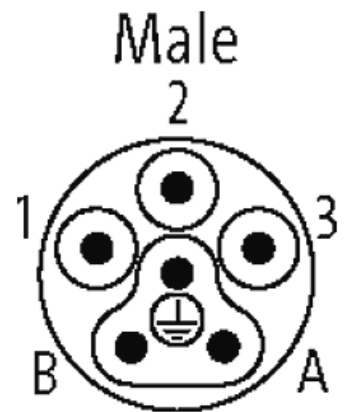

Product may differ from Image